

SIMPLEX[®]

AUTOMATIC FUELPORT MANUAL

with Touchscreen - April 2012

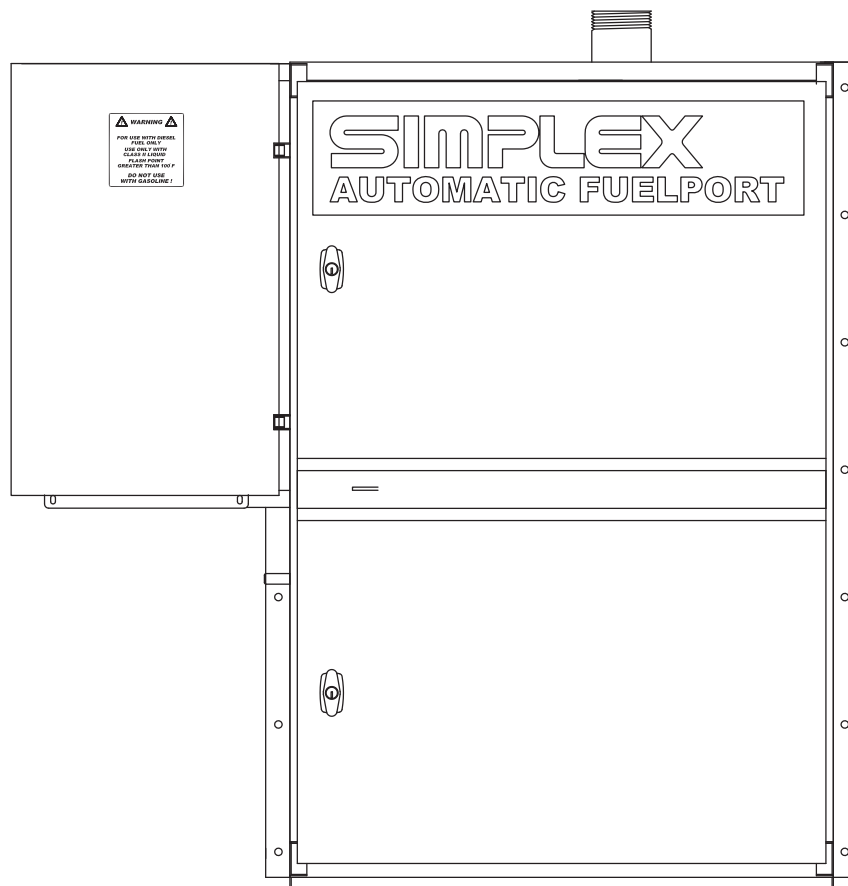

Contents

DESCRIPTION	2
INSTALLATION.....	3
AUTOMATIC FUELPORT	5
SEQUENCE OF OPERATION	5
TC-25 TANK COMMANDER.....	7
Specifications.....	7
Installation	8
Transmitter	8
Connection	8
LEVEL TRANSMITTER OPERATIONAL VERIFICATION	8
AUTOMATIC FUELPORT TOUCHSCREEN OPERATION.....	9
INCHES OF FUEL TO OUTPUT	
CURRENT CONVERSION CHART	10
APPENDIX A - ABBREVIATIONS USED IN THIS MANUAL.....	15
APPENDIX B - TECHNICAL DATA	16

The information herein is the property of Simplex, Inc. and/or its subsidiaries. Without written permission, any copying, transmitting to others, and other use except that for which it is loaned, is prohibited.

DESCRIPTION

The Simplex Automatic FuelPort is a factory packaged system for control of filling operations of above-ground tanks that are filled from pumper trucks. The Automatic FuelPort provides a ready means of ground level connection of the fill hose, and captures spills that may occur at the fill point during filling operations. The Automatic FuelPort alerts the operator when the tank is full with filling operations locked out at High Level. A leak detection circuit prevents filling of leaking tanks. Visual and audible level and leak alarms and continuous level indication are provided.

The Simplex Automatic FuelPort includes an electronic monitor and control system used to control tank filling and prevent overflow. The Automatic FuelPort can be used with an electric solenoid valve or a motorized ball valve.

During filling operations, the Automatic FuelPort provides continuous level indication, Tank Full audible and visual alarm, High Level audible and visual alarm and shut off.

The Automatic FuelPort can receive a signal from an external tank leak sensor to activate an alarm, send a remote signal and automatically close the fill valve.

The Simplex Automatic FuelPort is available for use with fuel oil (Class-II liquids) or gasoline (Class-I liquids).

Single or multiple tank controllers are available. Multiple tank controllers allow operator selection of the tank to be filled with automatic lockout of all other tanks.

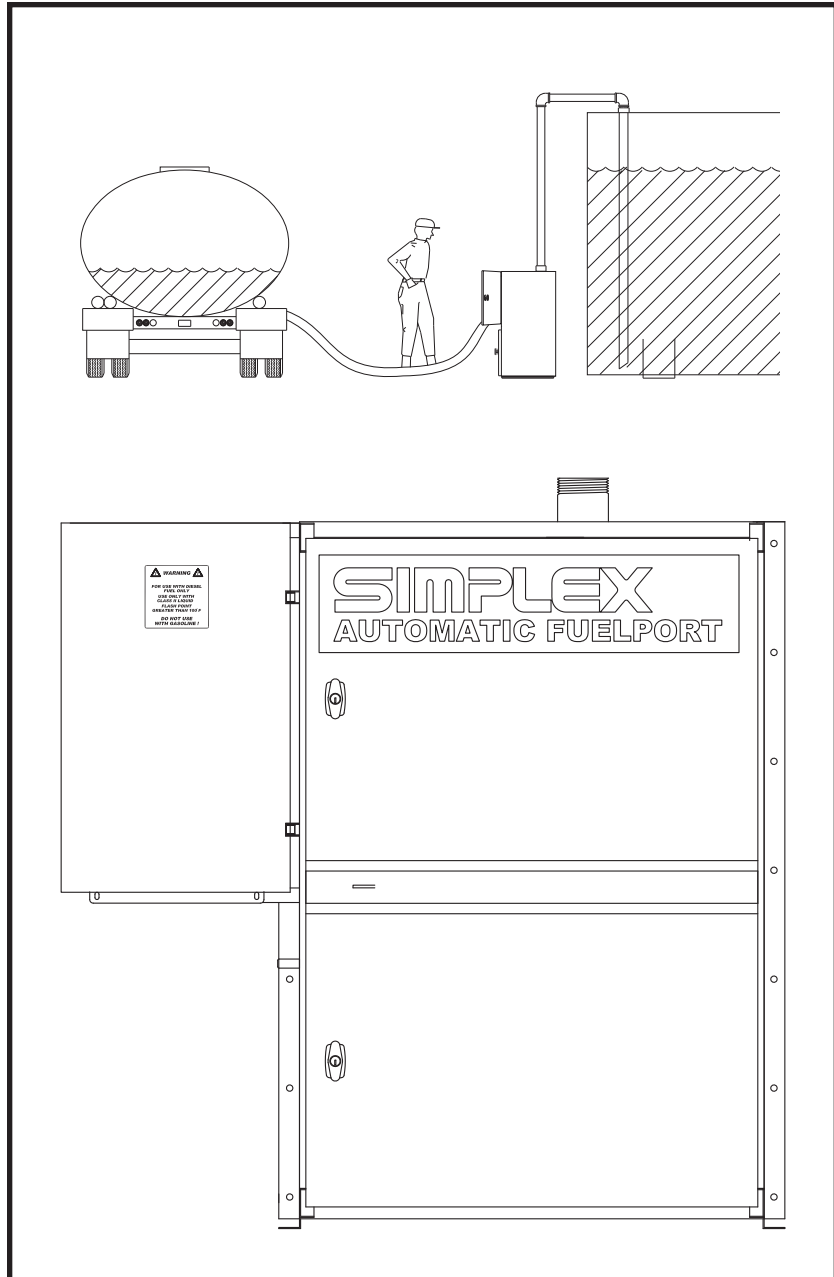

See the Specifications Sheet in the front of this manual for detailed information and a list of drawings for this Automatic FuelPort.

INSTALLATION

1. See Pictorial Drawings:

- a. Properly mount and attach all components as shown using the mounting feet/holes provided.
- b. Install Automatic FuelPort Transducer, Floatswitch Assembly and optional Tank Leak Floatswitch, if provided, in the appropriate NPT fittings in the top of the fuel storage tank(s).
- c. Install motorized ball valves, if provided, at appropriate points in fuel system
- c. Connect Automatic FuelPort Ground Stud to earthground.

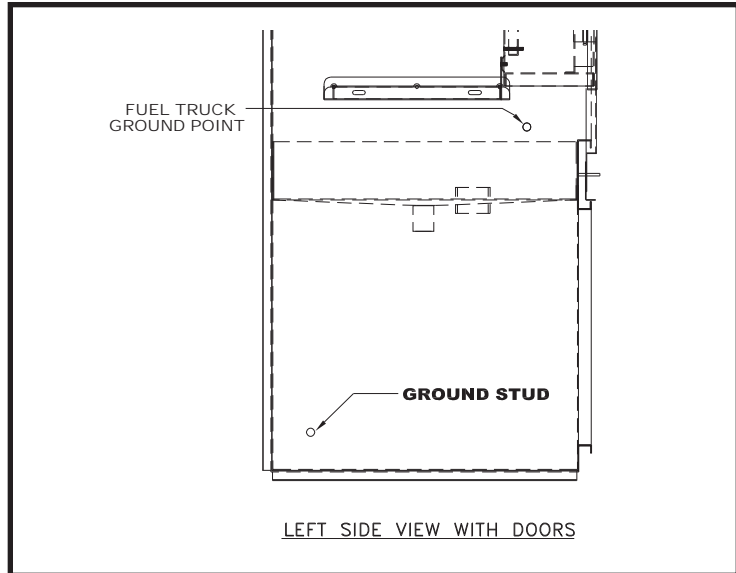

Ground Stud and Fuel Truck Ground Point

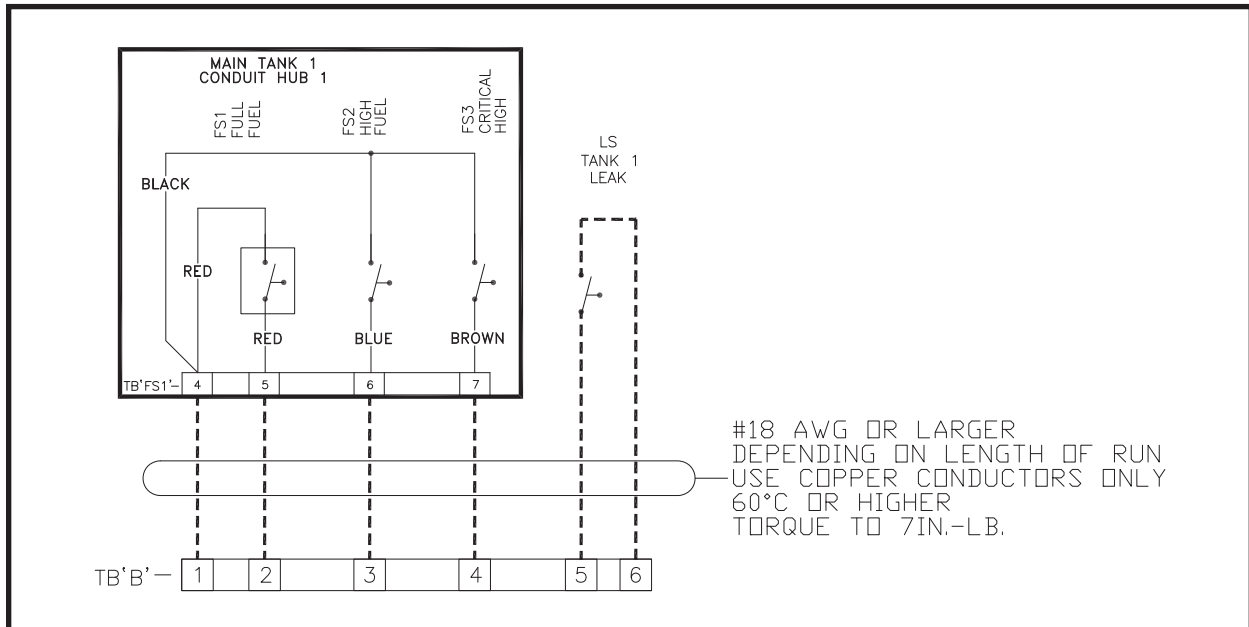

Typical Floatswitch Connections to TB'B'

2. See Electrical Drawings:

- a. Using #20 AWG or greater wire, connect the contacts in the Floatswitch Assembly Conduit Hub to contacts on TB'B' as shown.
- b. If needed, using #20 AWG or greater wire, connect optional Tank Leak Alarm Floatswitch to contacts to TB'B' as shown.

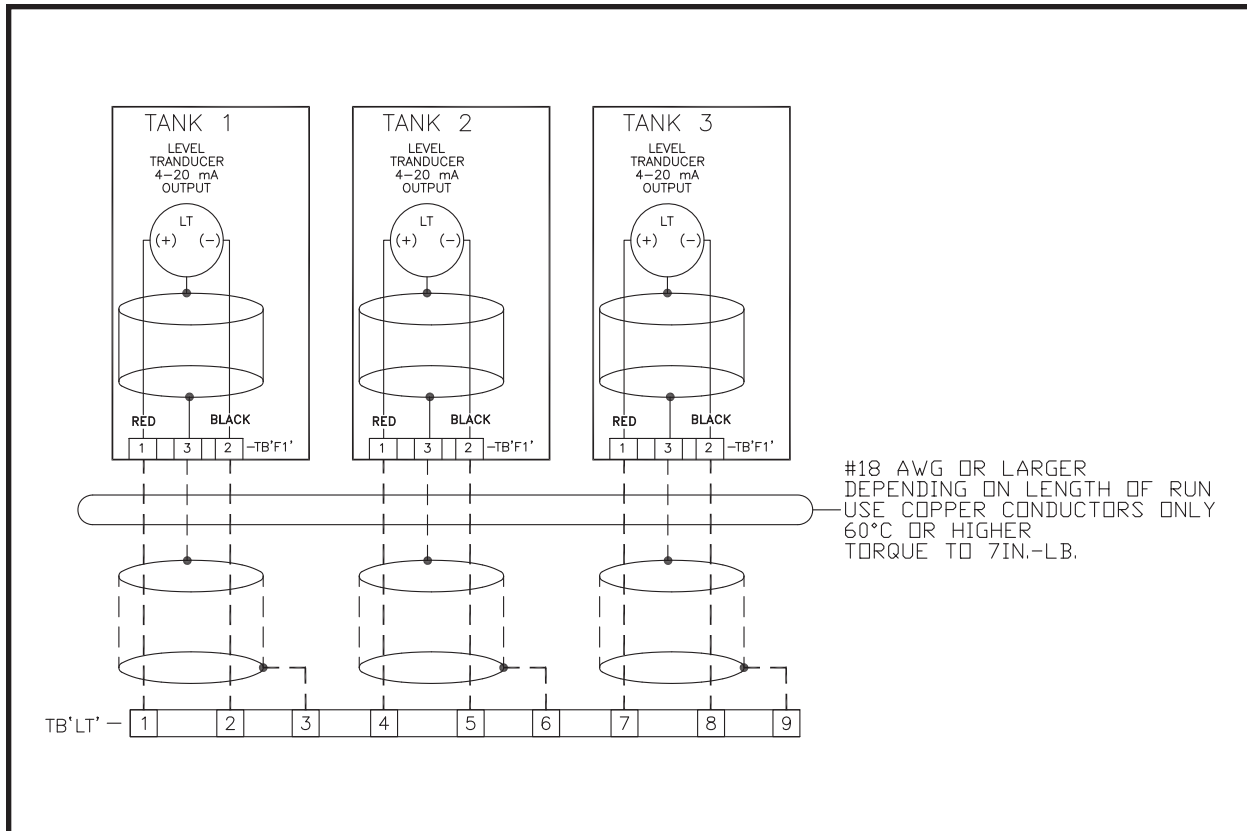

Typical Transmitter and PLC Analog Input Electrical Schematic

- c. Using #14 AWG or greater wire, connect motorized ball valves to TB'BV' as shown.
- d. If needed, connect customer supplied alarm devices to contacts on TB'C' as shown. Contacts are rated 10A@30VDC; 115/230Vac
- e. Using #20 AWG or greater shielded wire, connect Level Transducer to LB'LT' as shown.
- f. Using #14 AWG or greater wire, connect control power of 115Vac, 1ø, 60Hz to contacts at terminal block TB'PS' as shown. A 15 amp fuse or circuit breaker is required, maximum, supplied by others.

Fill Control Valve Open, Tank Fill Alarm and High Fuel Alarm contacts are standard.

Over Fill Alarm, Tank Leak Alarm and Low Fuel Alarm contacts are optional.

AUTOMATIC FUELPORTR SEQUENCE OF OPERATION

1. Connect a ground cable from the truck to the provided ground stud.
2. Unlock the fill box and connect a delivery hose to the hose coupling.
3. Turn the Control Power switch to the ON position.
4. Select the tank to fill using F1 or F2 on the digital display.
5. Press F4 on the digital display to open the fill valve for the selected tank. (Only one fill valve may be open at a time.)
6. The fill valve opens.
7. Open the valve on the truck.
8. Start the delivery pump on the truck (if applicable).
9. Fuel is delivered to the tank.
10. Delivery may be stopped at any time by pressing F5 on the digital display to close the fill valve.
11. When the Tank Full level is reached, an alarm will be displayed and the tank fill valve will close. To reopen the valve for 30 seconds, press F3 to override the high fuel level and top off the tank or drain the hose.
12. When the Tank High level is reached, an alarm will be displayed; the fill valve will close and cannot be reopened until the fuel level falls below high level.
13. If any tank in the system reaches the Critical High level, an alarm will be displayed and no fill valves will be allowed to open.
14. During a filling operation, if any tank not selected for filling reaches Full, High or Leak, the selected tanks fill valve will close. At this point the operator can reopen the selected fill valve if desired.

F1 : TANK SELECT TOGGLE UP
 F2 : TANK SELECT TOGGLE DOWN
 F3 : FILL OVERRIDE
 F4 : OPEN SELECTED MOTORIZED BALL VALVE
 F5 : CLOSE SELECTED MOTORIZED BALL VALVE

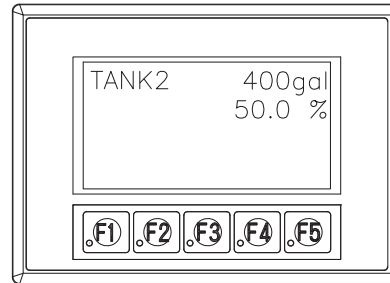

Automatic Fuel Port

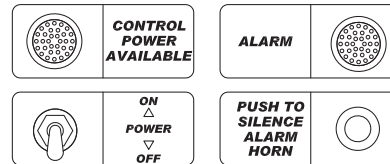

ALARM HORN

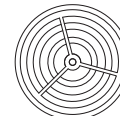

WARNING! Start up procedure required!
 See procedure on subpanel inside!
 Must be grounded for operator safety.
 See Operation Manual.

Simplex, Inc., Rising Moon Road
 Springfield, Illinois 62711
 (217) 483-1600 (24 Hr.) Fax (217) 483-1616
 www.simplexdirect.com

- Power Available lamp L1
- Control Power switch S1
- Alarm Summary lamp L2
- Alarm Silence pushbutton PB
- Select next tank F1
- Select previous tank F2
- Temporarily override high fuel level.... F3
- Open tank valve F4
- Close tank valve F5

15. Stop the delivery pump on the truck.
16. Close the valve on the truck.
17. Drain the delivery hose.
18. When the filling operation is complete, if the tank fill valve is open, press F5 on the digital display to close it.
19. Disconnect the delivery hose.
20. Turn the Control Power switch to the Off position.
21. Close and lock the fill box.
22. Fuel delivery is complete; disconnect the ground cable from the trucker's grounding stud.

SPECIFICATIONS**Power**

120VAC or 24VDC (specify),
<100mA

Accuracy

2%

Display

1.5 Digit LCD
0-9999.9/0-99999

Resolution

Percent display: 1/10 percent

Gallons/liters display:
1/10 unit to 199.9
1 unit to 1999

Temperature range*

Display:
-31 - 167°F
-35 - 75°C

Transmitter:
-50 - 125°F
-46 - 52°C

*Caution: Do not exceed flash
point of tank contents

TC-25 TANK COMMANDER

The TC-25 Tank Commander is an economical instrument for accurate liquid level indication scaled in percent level for cylindrical and square tanks or in gallons/liters for square tanks only. The TC-25 can be in an open construction suitable for flush panel mounting or in an enclosure for wall mounting.

The TC-25 is for use with Class-II liquids (fuel oils, lubricating oils) only. **Do not use with gasoline or other Class I liquids.**

The TC-25 is a fully electronic device using a submersible level transmitter. The Receiver/Indicator displays tank level on a 1-inch LCD display. Level indication can be scaled in percent level for cylindrical tanks and square tanks or in percent level or gallons/liters for square/rectangular tanks.

The Transmitter is installed in a 1½-inch NPT or larger pipe fitting in the tank top. The length of the Transmitter is equal to the inside height of the tank and is available for any tank height. However, transmitters are stocked in 2 standard ranges: 0-68 in. and 0-136 in.

Convenient user adjustment potentiometers allow field calibration for specific tank constructions.

The TC-25 is powered from either 120V AC or 24V DC (voltage must be specified when ordering). Refer to electrical drawing.

The TC-25 has a 4-20 mA output linear with fuel level.

INSTALLATION

TRANSMITTER

The Transmitter is mounted on the tank top and must span entire inside height of tank for an accurate measurement (See *Standard Transmitter Drawing*).

A weatherproof conduit hub with 0.50NPT conduit fittings is provided for electrical connections.

Connection

Using a 3 conductor shielded cable, #20 AWG, connect TC-25 Level Transmitter to terminal block as shown on the electrical drawings.

LEVEL TRANSMITTER OPERATIONAL VERIFICATION

1. Check drawings for changes in specifications (e.g. size of tank, percentage or gallons).
2. If there are no changes in the specifications the unit is ready for a system check.

WARNING

Care must be taken when installing the system. Incorrect wiring will damage the Receiver/Indicator. Follow drawing provided with system for proper installation.

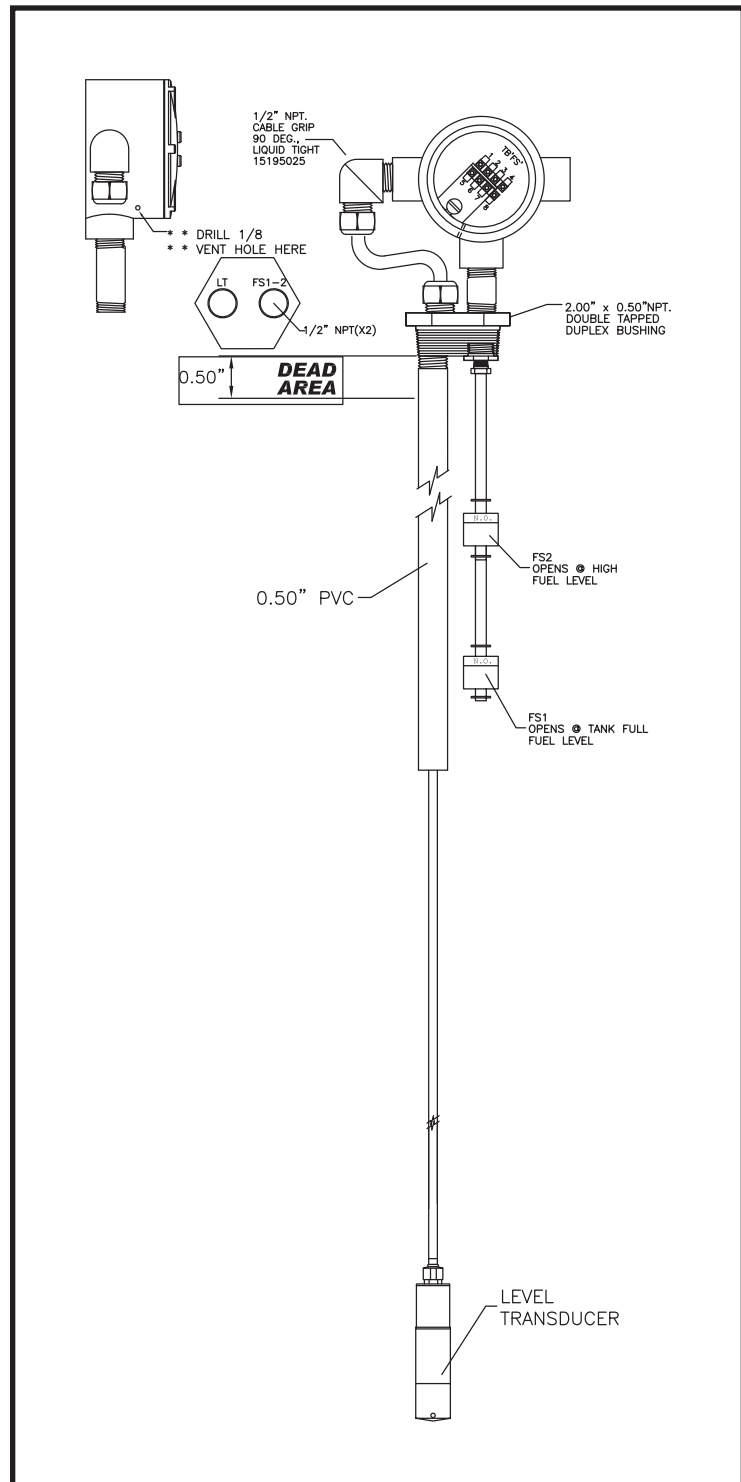

Standard Transmitter

AUTOMATIC FUELPORT TOUCHSCREEN OPERATION

1. Main Screen

- F1 / F2 Select tank
 - F3 High level fill override
 - F4 Open valve to selected tank
 - F5 Close valve to selected tank
- To access system setup, press and hold F1+F2+F3

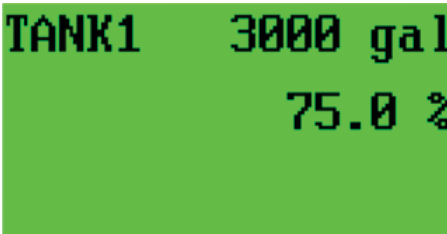

2. System Setup

- F1 Access tank setup
- F2 Calibrate transducer (factory set)
- F3 Select PLC Modbus node
- F4 Set PLC analog card type (factory set)
- F5 Enable/disable pump

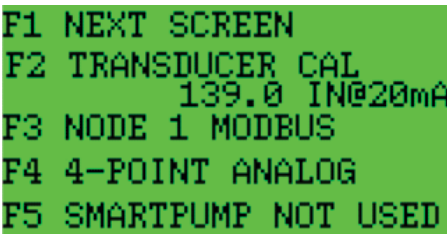

3. Tank Setup

- F1 Select next tank
- F2 Set tank capacity (0 for tank not used)
- F3 Set tank inside height (0 for tank not used)
- F5 Toggle square tank / round tank / tank not used

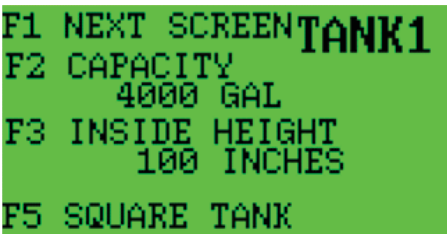

4. Status Indications

- Critical High Fuel (>95% by float)
– Fill Disabled
- High Fuel (>90% by float)
– Fill disabled, but may be overridden with F3
- Refill (<55% by transducer)
- Low Fuel (<10% by transducer)

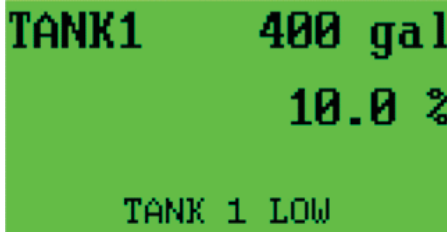
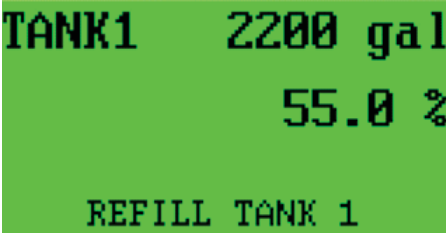
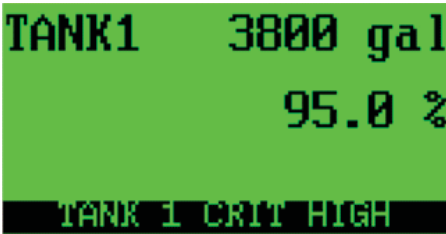

INCHES OF FUEL TO OUTPUT CURRENT CONVERSION CHART

mA = TC-25 Current Output

7.5 PSI Transducer PN 25328255		1 PSI Transducer PN 25328251		7.5 PSI Transducer PN 25328255		1 PSI Transducer PN 25328251	
Inches	mA	Inches	mA	Inches	mA	Inches	mA
0	4.000	0	4.000	19.5	5.224	19.5	13.176
0.5	4.031	0.5	4.235	20	5.255	20	13.412
1	4.063	1	4.471	20.5	5.286	20.5	13.647
1.5	4.094	1.5	4.706	21	5.318	21	13.882
2	4.125	2	4.941	21.5	5.349	21.5	14.118
2.5	4.157	2.5	5.176	22	5.380	22	14.353
3	4.188	3	5.412	22.5	5.412	22.5	14.588
3.5	4.220	3.5	5.647	23	5.443	23	14.824
4	4.251	4	5.882	23.5	5.475	23.5	15.059
4.5	4.282	4.5	6.118	24	5.506	24	15.294
5	4.314	5	6.353	24.5	5.537	24.5	15.529
5.5	4.345	5.5	6.588	25	5.569	25	15.765
6	4.376	6	6.824	25.5	5.600	25.5	16.000
6.5	4.408	6.5	7.059	26	5.631	26	16.235
7	4.439	7	7.294	26.5	5.663	26.5	16.471
7.5	4.471	7.5	7.529	27	5.694	27	16.706
8	4.502	8	7.765	27.5	5.725	27.5	16.941
8.5	4.533	8.5	8.000	28	5.757	28	17.176
9	4.565	9	8.235	28.5	5.788	28.5	17.412
9.5	4.596	9.5	8.471	29	5.820	29	17.647
10	4.627	10	8.706	29.5	5.851	29.5	17.882
10.5	4.659	10.5	8.941	30	5.882	30	18.118
11	4.690	11	9.176	30.5	5.914	30.5	18.353
11.5	4.722	11.5	9.412	31	5.945	31	18.588
12	4.753	12	9.647	31.5	5.976	31.5	18.824
12.5	4.784	12.5	9.882	32	6.008	32	19.059
13	4.816	13	10.118	32.5	6.039	32.5	19.294
13.5	4.847	13.5	10.353	33	6.071	33	19.529
14	4.878	14	10.588	33.5	6.102	33.5	19.765
14.5	4.910	14.5	10.824	34	6.133	34	20.000
15	4.941	15	11.059	34.5	6.165		
15.5	4.973	15.5	11.294	35	6.196		
16	5.004	16	11.529	35.5	6.227		
16.5	5.035	16.5	11.765	36	6.259		
17	5.067	17	12.000	36.5	6.290		
17.5	5.098	17.5	12.235	37	6.322		
18	5.129	18	12.471	37.5	6.353		
18.5	5.161	18.5	12.706	38	6.384		
19	5.192	19	12.941	38.5	6.416		

INCHES OF FUEL TO OUTPUT CURRENT CONVERSION CHART CONT'D

mA = TC-25 Current Output

7.5 PSI Transducer PN 25328255		7.5 PSI Transducer PN 25328255		7.5 PSI Transducer PN 25328255	
<u>Inches</u>	<u>mA</u>	<u>Inches</u>	<u>mA</u>	<u>Inches</u>	<u>mA</u>
39	6.447	58.5	7.671	78	8.894
39.5	6.478	59	7.702	78.5	8.925
40	6.510	59.5	7.733	79	8.957
40.5	6.541	60	7.765	79.5	8.988
41	6.573	60.5	7.796	80	9.020
41.5	6.604	61	7.827	80.5	9.051
42	6.635	61.5	7.859	81	9.082
42.5	6.667	62	7.890	81.5	9.114
43	6.698	62.5	7.922	82	9.145
43.5	6.729	63	7.953	82.5	9.176
44	6.761	63.5	7.984	83	9.208
44.5	6.792	64	8.016	83.5	9.239
45	6.824	64.5	8.047	84	9.271
45.5	6.855	65	8.078	84.5	9.302
46	6.886	65.5	8.110	85	9.333
46.5	6.918	66	8.141	85.5	9.365
47	6.949	66.5	8.173	86	9.396
47.5	6.980	67	8.204	86.5	9.427
48	7.012	67.5	8.235	87	9.459
48.5	7.043	68	8.267	87.5	9.490
49	7.075	68.5	8.298	88	9.522
49.5	7.106	69	8.329	88.5	9.553
50	7.137	69.5	8.361	89	9.584
50.5	7.169	70	8.392	89.5	9.616
51	7.200	70.5	8.424	90	9.647
51.5	7.231	71	8.455	90.5	9.678
52	7.263	71.5	8.486	91	9.710
52.5	7.294	72	8.518	91.5	9.741
53	7.325	72.5	8.549	92	9.773
53.5	7.357	73	8.580	92.5	9.804
54	7.388	73.5	8.612	93	9.835
54.5	7.420	74	8.643	93.5	9.867
55	7.451	74.5	8.675	94	9.898
55.5	7.482	75	8.706	94.5	9.929
56	7.514	75.5	8.737	95	9.961
56.5	7.545	76	8.769	95.5	9.992
57	7.576	76.5	8.800	96	10.024
57.5	7.608	77	8.831	96.5	10.055
58	7.639	77.5	8.863	97	10.086

INCHES OF FUEL TO OUTPUT CURRENT CONVERSION CHART CONT'D

mA = TC-25 Current Output

7.5 PSI Transducer PN 25328255		7.5 PSI Transducer PN 25328255		7.5 PSI Transducer PN 25328255	
<u>Inches</u>	<u>mA</u>	<u>Inches</u>	<u>mA</u>	<u>Inches</u>	<u>mA</u>
97.5	10.118	117	11.341	136.5	12.565
98	10.149	117.5	11.373	137	12.596
98.5	10.180	118	11.404	137.5	12.627
99	10.212	118.5	11.435	138	12.659
99.5	10.243	119	11.467	138.5	12.690
100	10.275	119.5	11.498	139	12.722
100.5	10.306	120	11.529	139.5	12.753
101	10.337	120.5	11.561	140	12.784
101.5	10.369	121	11.592	140.5	12.816
102	10.400	121.5	11.624	141	12.847
102.5	10.431	122	11.655	141.5	12.878
103	10.463	122.5	11.686	142	12.910
103.5	10.494	123	11.718	142.5	12.941
104	10.525	123.5	11.749	143	12.973
104.5	10.557	124	11.780	143.5	13.004
105	10.588	124.5	11.812	144	13.035
105.5	10.620	125	11.843	144.5	13.067
106	10.651	125.5	11.875	145	13.098
106.5	10.682	126	11.906	145.5	13.129
107	10.714	126.5	11.937	146	13.161
107.5	10.745	127	11.969	146.5	13.192
108	10.776	127.5	12.000	147	13.224
108.5	10.808	128	12.031	147.5	13.255
109	10.839	128.5	12.063	148	13.286
109.5	10.871	129	12.094	148.5	13.318
110	10.902	129.5	12.125	149	13.349
110.5	10.933	130	12.157	149.5	13.380
111	10.965	130.5	12.188	150	13.412
111.5	10.996	131	12.220	150.5	13.443
112	11.027	131.5	12.251	151	13.475
112.5	11.059	132	12.282	151.5	13.506
113	11.090	132.5	12.314	152	13.537
113.5	11.122	133	12.345	152.5	13.569
114	11.153	133.5	12.376	153	13.600
114.5	11.184	134	12.408	153.5	13.631
115	11.216	134.5	12.439	154	13.663
115.5	11.247	135	12.471	154.5	13.694
116	11.278	135.5	12.502	155	13.725
116.5	11.310	136	12.533	155.5	13.757

INCHES OF FUEL TO OUTPUT CURRENT CONVERSION CHART CONT'D

mA = TC-25 Current Output

7.5 PSI Transducer PN 25328255		7.5 PSI Transducer PN 25328255		7.5 PSI Transducer PN 25328255	
<u>Inches</u>	<u>mA</u>	<u>Inches</u>	<u>mA</u>	<u>Inches</u>	<u>mA</u>
156	13.788	175.5	15.012	195	16.235
156.5	13.820	176	15.043	195.5	16.267
157	13.851	176.5	15.075	196	16.298
157.5	13.882	177	15.106	196.5	16.329
158	13.914	177.5	15.137	197	16.361
158.5	13.945	178	15.169	197.5	16.392
159	13.976	178.5	15.200	198	16.424
159.5	14.008	179	15.231	198.5	16.455
160	14.039	179.5	15.263	199	16.486
160.5	14.071	180	15.294	199.5	16.518
161	14.102	180.5	15.325	200	16.549
161.5	14.133	181	15.357	200.5	16.580
162	14.165	181.5	15.388	201	16.612
162.5	14.196	182	15.420	201.5	16.643
163	14.227	182.5	15.451	202	16.675
163.5	14.259	183	15.482	202.5	16.706
164	14.290	183.5	15.514	203	16.737
164.5	14.322	184	15.545	203.5	16.769
165	14.353	184.5	15.576	204	16.800
165.5	14.384	185	15.608	204.5	16.831
166	14.416	185.5	15.639	205	16.863
166.5	14.447	186	15.671	205.5	16.894
167	14.478	186.5	15.702	206	16.925
167.5	14.510	187	15.733	206.5	16.957
168	14.541	187.5	15.765	207	16.988
168.5	14.573	188	15.796	207.5	17.020
169	14.604	188.5	15.827	208	17.051
169.5	14.635	189	15.859	208.5	17.082
170	14.667	189.5	15.890	209	17.114
170.5	14.698	190	15.922	209.5	17.145
171	14.729	190.5	15.953	210	17.176
171.5	14.761	191	15.984	210.5	17.208
172	14.792	191.5	16.016	211	17.239
172.5	14.824	192	16.047	211.5	17.271
173	14.855	192.5	16.078	212	17.302
173.5	14.886	193	16.110	212.5	17.333
174	14.918	193.5	16.141	213	17.365
174.5	14.949	194	16.173	213.5	17.396
175	14.980	194.5	16.204	214	17.427

INCHES OF FUEL TO OUTPUT CURRENT CONVERSION CHART CONT'D

mA = TC-25 Current Output

7.5 PSI Transducer PN 25328255		7.5 PSI Transducer PN 25328255		7.5 PSI Transducer PN 25328255	
<u>Inches</u>	<u>mA</u>	<u>Inches</u>	<u>mA</u>	<u>Inches</u>	<u>mA</u>
214.5	17.459	234	18.682	253.5	19.906
215	17.490	234.5	18.714	254	19.937
215.5	17.522	235	18.745	254.5	19.969
216	17.553	235.5	18.776	255	20.000
216.5	17.584	236	18.808		
217	17.616	236.5	18.839		
217.5	17.647	237	18.871		
218	17.678	237.5	18.902		
218.5	17.710	238	18.933		
219	17.741	238.5	18.965		
219.5	17.773	239	18.996		
220	17.804	239.5	19.027		
220.5	17.835	240	19.059		
221	17.867	240.5	19.090		
221.5	17.898	241	19.122		
222	17.929	241.5	19.153		
222.5	17.961	242	19.184		
223	17.992	242.5	19.216		
223.5	18.024	243	19.247		
224	18.055	243.5	19.278		
224.5	18.086	244	19.310		
225	18.118	244.5	19.341		
225.5	18.149	245	19.373		
226	18.180	245.5	19.404		
226.5	18.212	246	19.435		
227	18.243	246.5	19.467		
227.5	18.275	247	19.498		
228	18.306	247.5	19.529		
228.5	18.337	248	19.561		
229	18.369	248.5	19.592		
229.5	18.400	249	19.624		
230	18.431	249.5	19.655		
230.5	18.463	250	19.686		
231	18.494	250.5	19.718		
231.5	18.525	251	19.749		
232	18.557	251.5	19.780		
232.5	18.588	252	19.812		
233	18.620	252.5	19.843		
233.5	18.651	253	19.875		

APPENDIX A - ABBREVIATIONS USED IN THIS MANUAL

Listed below are abbreviations of terms found on Fuel Supply Systems. When following a drawing utilize this guide to define abbreviated system and component names. As this is a master list, drawings and text pertaining to your equipment may not contain all these terms.

AC -Alternating Current	MOT -Motor
AHR -Alarm Horn Relay	N.C. -Normally Closed
AR -Alarm Horn	NEC -National Electric Code
BPRV -Back Pressure Regulating Valve	NEMA -National Electric Manufacturers Association
BRK -Motor/Pump Bracket	NFPA -National Fire Protection Association
BV -Ball Valve	N.O. -Normally Open
C -Contactor	NP -Nameplate
CB -Circuit Breaker	NPT -National Pipe Thread
CSR -Check Strainer Relay	O.D. -Outside Diameter
CV -Check Valve	OLR -Over Load Relay
DC -Direct Current	OPT -Option
DPDT -Double Pole Double Throw	PCB -Printed Circuit Board
F -Fuse	PCRX -Pump Control Relays
FLS -Flowswitch	PG -Pressure Gauge
FS -Floatswitch	PLR -Pipe Leak Relay
FSR -Simplex Fuel Strainer	PRV -Pressure Relief Valve
GA -Gauge	PS -Pressure Switch
GAL -Gallons	PSI -Pounds Per Square Inch
GPM -Gallons Per Minute	PSR -Pressure Switch Relay
HFL -High Fuel Level Relay	PRR -Pump Running Relay
HG -Mercury	SC -Swing Check Valve
HP -Horsepower	SOL -Solenoid
HZ -Hertz	SST -Simplex Super Tank
I.D. -Inside Diameter	TB -Terminal Block
JB -Junction Box	T -Control Transformer
Hz -Hertz	TDR -Time Delay Relay
INHG -Inches of Mercury	TEFC -Totally Enclosed, Fan Cooled
L -Lamp	THR -Tank Heater Control Relay
L.E.D. -Light Emitting Diode	TS -Transducer Pressure Switch
LAFD -Los Angeles Fire Department	V -Voltage
LFF -Loss of Flow Relay	VAC -Voltage, Alternating Current
LFL -Low Fuel Level Relay	VDC -Voltage, Direct Current
LPR -Low Pressure Relay	VG -Vacuum Gauge
MDB -Main Distribution Block	
MDS -Main Disconnect Switch	

APPENDIX B - TECHNICAL DATA

Thermal expansion of oil is approximately 1 cubic inch per 1 gallon per 10°F rise in temperature.

Hydraulic Formulas

$$\text{Horsepower} = \frac{\text{GPM} \times \text{PSI}}{1714}$$

$$\text{Torque (lb. in.)} = \frac{\text{CU IN./REV.} \times \text{PSI}}{2}$$

$$\text{Torque (lb. in.)} = \frac{\text{HP} \times 63025}{\text{RPM}}$$

$$\text{Flow (gpm)} = \frac{\text{CU IN./REV} \times \text{RPM}}{231}$$

Head and Pressure Equivalents

When converting pressure from feet of water to P.S.I., the specific gravity of the liquid must be considered.

Here are some typical conversion figures:

1 P.S.I.=2.30 feet of water
(specific gravity 1.0)

1 P.S.I.=2.88 feet of oil
(specific gravity 0.8)

Conversion Factors

1HP = 33,000 ft. lbs. per minute
1HP = 42.4 btu per minute
1HP = 0.746 kwhr (kilowatt hours)

1 U.S. gallon= 231 cubic inches

Pipe Volume varies as the square of the diameter; volume in gallons = 0.0034 D² L where:
D=inside diameter of pipe in inches;
L=length in inches

$$\text{Velocity in feet per sec.} = \frac{0.408 \times \text{flow (gpm)}}{D^2}$$

where:

D=inside diameter of pipe in inches

Atmospheric pressure at sea level = 14.7PSI
Atmospheric pressure decreases approximately 0.41PSI for each one thousand feet of elevation up to 23,000 feet.

Pressure (PSI) = feet head x 0.433 x specific gravity

Specific gravity of oil is approximately 0.85.

PRESSURE AND CONVERSION TABLE		
Feet Water	PSI Oil	PSI Water
1	.35	.43
2	.70	.87
3	1.05	1.3
4	1.4	1.73
5	1.75	2.17
10	3.5	4.33
15	5.2	6.5
20	7.0	8.66
25	8.7	10.8
30	10.5	13.0
35	12.2	15.2
40	14.0	17.3
45	15.7	19.5
50	17.5	21.7
55	19.2	23.9
60	21.0	26.0
65	22.7	28.1
70	24.5	30.5
75	26.2	32.5
80	28.0	34.6
85	29.7	36.8
90	31.5	39.0

SUPER X-L PUMP

PUMP MODEL	DISPLACEMENT IN ³ (CC/REV.)	RPM	Flow, GPM (LPM)				
			100 PSI (6.9 Bar)	1000 PSI (69 Bar)	1500 PSI (103 Bar)	2000 PSI (138 Bar)	2500 PSI (172 Bar)
SUPER XL-11	.262 (4.29)	1800	1.99 (7.54)	1.86 (7.05)	1.79 (6.78)	1.73 (6.56)	1.66 (6.29)
SUPER XL-39	.942 (15.44)	1800	7.08 (26.83)	6.87 (26.04)	6.77 (25.66)	6.66 (25.24)	6.56 (24.86)
SUPER XL-62	1.47 (24.14)	1800	11.10 (42.07)	10.81 (40.97)	10.70 (40.55)	10.60 (40.17)	10.40 (39.42)
SUPER XL-90	2.23 (36.5)	1800	16.70 (63.29)	16.50 (62.54)	16.30 (61.78)		
SUPER XL-114	3.35 (54.9)	1800	25.30 (95.89)	24.90 (94.37)	24.60 (93.23)	24.40 (92.48)	

PUMP PERFORMANCE DATA 40 SSU • 200 SSU • 500SSU (SERIES 420)

MODEL	RPM	40SSU						200SSU											
		0 PSI		50 PSI		100 PSI		0 PSI		50 PSI		100 PSI		200 PSI		300 PSI		500 PSI	
		GPM	HP	GPM	HP	GPM	HP	GPM	HP	GPM	HP	GPM	HP	GPM	HP	GPM	HP	GPM	HP
420	1200	1.9	¼	1.7	¼	1.5	⅓	1.9	⅛	1.9	⅛	1.7	¼	1.5	⅓	1.4	½	1.2	¾
	1800	2.9	¼	2.7	½	2.5	½	2.9	⅛	2.8	¼	2.7	⅓	2.5	½	2.3	¾	2.1	1½
422	1200	3.7	⅓	3.4	½	3.1	¾	3.7	⅛	3.4	¼	3.1	¼	2.8	½	3.0	1	2.8	1½
	1800	5.4	½	4.9	¾	4.8	1	5.5	¼	4.9	⅓	4.9	½	4.6	¾	4.3	1½	3.8	2
424	1200	9.0	¼	7.6	¾	6.0	1	9.0	⅓	8.6	½	8.2	1	7.7	2	7.1	3	-	-
	1800	11.5	⅓	11.1	1	10.7	1½	13.7	½	13.3	1	12.9	1½	10.9	3	10.2	5	-	-
426	1200	10.0	¾	8.2	1	6.3	1½	12.0	¾	11.0	1	10.5	1½	-	-	-	-	-	-
	1800	15.0	1	12.2	1½	9.5	3	18.0	1	17.0	1½	16.0	3	-	-	-	-	-	-
428	1200	20.9	¾	17.4	1½	14.0	3	24.5	¾	23.8	1½	23.0	3	-	-	-	-	-	-
	1800	31.2	1½	26.1	3	21.0	5	37.0	1½	36.0	3	35.0	5	-	-	-	-	-	-
429	1200	34.0	1½	29.0	3	22.0	5	41.0	1½	40.0	3	38.5	5	-	-	-	-	-	-
	1800	53.0	3	45.0	5	36.0	7½	61.7	3	61.0	5	60.0	7½	-	-	-	-	-	-

MODEL	RPM	500SSU											
		0 PSI		50 PSI		100 PSI		200 PSI		300 PSI		500 PSI	
		GPM	HP	GPM	HP	GPM	HP	GPM	HP	GPM	HP	GPM	HP
420	1200	1.8	⅛	1.8	⅛	1.7	¼	1.6	⅓	1.4	½	1.1	1
	1800	2.7	¼	2.7	¼	2.6	⅓	2.5	½	2.4	1	2.2	1½
422	1200	3.6	⅛	3.5	¼	3.3	⅓	2.8	½	2.7	¾	2.0	1½
	1800	5.3	¼	5.2	⅓	4.9	½	4.4	1	4.0	1½	3.0	2
424	1200	8.7	½	8.6	¾	8.5	1½	8.2	2	7.8	3	-	-
	1800	2.9	1	12.8	1½	12.7	2	12.5	3	12.0	5	-	-
426	1200	12.0	1	11.5	1½	11.0	2	-	-	-	-	-	-
	1800	18.1	1½	18.0	2	16.3	3	-	-	-	-	-	-
428	1200	24.5	1½	24.0	2	23.7	3	-	-	-	-	-	-
	1800	37.0	3	36.5	5	36.0	5	-	-	-	-	-	-
429	1200	41.0	2	40.0	5	39.5	5	-	-	-	-	-	-
	1800	61.7	5	61.0	5	60.0	7½	-	-	-	-	-	-

PUMP PERFORMANCE DATA 1000 SSU • 5000 SSU • 10000SSU (SERIES 420)

		1000SSU											
		0 PSI		50 PSI		100 PSI		200 PSI		300 PSI		500 PSI	
MODEL	RPM	GPM	HP	GPM	HP	GPM	HP	GPM	HP	GPM	HP	GPM	HP
420	1200	1.9	1/8	1.9	1/8	1.8	1/4	1.7	1/3	1.6	1/2	1.4	3/4
	1800	2.8	1/4	2.7	1/4	2.7	1/4	2.6	1/2	2.5	3/4	2.2	1 1/2
422	1200	3.5	1/4	3.4	1/4	3.3	1/3	3.0	3/4	2.6	3/4	1.8	1 1/2
	1800	5.0	1/3	4.9	1/2	4.9	3/4	4.7	1	4.2	1 1/2	3.4	2
424	1200	8.8	3/4	8.7	1	8.5	1 1/2	8.2	2	7.8	3	-	-
	1800	13.0	1 1/2	12.7	2	12.5	2	10.2	3	9.9	5	-	-
426	1200	12.5	1 1/2	12.0	1 1/2	11.8	2	-	-	-	-	-	-
	1800	18.7	2	18.5	2	17.0	3	-	-	-	-	-	-
428	1200	24.9	2	24.5	3	24.0	5	-	-	-	-	-	-
	1800	37.4	5	37.2	5	36.5	5	-	-	-	-	-	-
429	1200	41.7	3	41.7	5	41.0	5	-	-	-	-	-	-
	1800	61.7	5	61.7	7 1/2	61.0	7 1/2	-	-	-	-	-	-

		5000SSU									10000SSU						
		0 PSI		50 PSI		100 PSI		200 PSI		300 PSI		0 PSI		50 PSI		100 PSI	
MODEL	RPM	PM	HP	GPM	HP	GPM	HP	GPM	HP	GPM	HP	GPM	HP	GPM	HP	GPM	HP
420	1200	-	-	-	-	-	-	-	-	-	-	-	-	-	-	-	-
	1800	-	-	-	-	-	-	-	-	-	-	-	-	-	-	-	-
422	1200	-	-	-	-	-	-	-	-	-	-	-	-	-	-	-	-
	1800	-	-	-	-	-	-	-	-	-	-	-	-	-	-	-	-
424	1200	8.2	1	8.0	1 1/2	7.8	2	7.6	3	7.4	3	-	-	-	-	-	-
	1800	11.2	2	11.0	3	10.7	3	10.2	5	9.9	5	-	-	-	-	-	-
426	1200	12.5	2	12.4	2	11.6	3	-	-	-	-	-	-	-	-	-	-
	1800	18.7	3	18.5	3	17.5	5	-	-	-	-	-	-	-	-	-	-
428	1200	24.9	5	24.9	5	24.5	5	-	-	-	-	23.3	5	23.0	5	22.8	5
	1800	37.4	7 1/2	37.4	7 1/2	37.0	7 1/2	-	-	-	-	-	-	-	-	-	-
429	1200	41.7	5	41.0	5	40.0	7 1/2	-	-	-	-	-	-	-	-	-	-
	1800	61.7	7 1/2	61.7	7 1/2	61.0	10	-	-	-	-	-	-	-	-	-	-

MOTORS FOR PUMP DRIVE *CONTINUOUS DUTY, 40°C, UL RECOGNIZED***Single Phase Motors**

Split Phase Start, Drip Proof, Rigid Base, Class B
Insulation, Moderate Starting Torque, Sleeve Bearing

HP	RPM	Voltage	NEMA Frame	Bearing	Thermal Prot.	Service Factor	Approx. F.L. Amps
1/3	1800	115	48	Sleeve	Auto	1.0	6.6
1/2	1800	115	56	Sleeve	None	1.0	9.2

Capacitor Start, Drip Proof, Rigid Base, Class B Insulation,
High Starting Torque, Ball Bearing

HP	RPM	Voltage	NEMA Frame	Bearing	Thermal Prot.	Service Factor	Approx. F.L. Amps
1/3	1800	115/230	48	Sleeve	Auto	1.0	7.0/3.5
1/2	1800	115/230	56	Sleeve	Auto	1.0	9.2/4.6
3/4	1800	115/230	56	Sleeve	Auto	1.0	10.4/5.2

Capacitor Start, Drip Proof, Rigid Base, Class B Insulation,
Moderate Starting Torque, Sleeve Bearing

HP	RPM	Voltage	NEMA Frame	Thermal Prot.	Service Factor	Approx. F.L. Amps
1	1800	115/208-230	56	Auto	1.15	13.4/6.8-6.7
1 1/2	1800	115/208-230	56H	Auto	1.15	18.0/9.3-9.0
2	1800	115/208-230	145T	None	1.15	21.0/11.3-10.5
3	1800	115/208-230	184T	None	1.15	33.0/16.5
5	1800	208-230	184T	None	1.15	23.0-21.0
7 1/2	1800	208-230	215T	None	1.15	35.2

Capacitor Start, Totally Enclosed, Fan-Cooled, Rigid
Base, Class B Insulation, NEMA-L (≥ 1.0 HP) High Starting
Torque, Ball Bearing

HP	RPM	Voltage	NEMA Frame	Thermal Prot.	Service Factor	Approx. F.L. Amps
1/3	1800	115/208-230	56	Auto	1.15	6.6/3.1-3.3
1/2	1800	115/208-230	56	Auto	1.15	8.8/4.2-4.4
3/4	1800	115/208-230	56	Auto	1.15	11.0/5.4-5.5
1	1800	115/208-230	56	Auto	1.15	13.4/6.8-6.7
1 1/2	1800	115/208-230	56H	Auto	1.15	15.2/8.2-7.6
2	1800	115/208-230	145T	None	1.15	18.8/9.4
3	1800	115/208-230	184T	None	1.0	34.0/17.0
5	1800	208-230	213T	None	1.0	27.5-26.0
7 1/2	1800	208-230	215T	None	1.0	36.5-33.0

MOTORS FOR PUMP DRIVE *CONTINUOUS DUTY, 40°C, UL RECOGNIZED*

Three Phase Motors

Drip Proof, Rigid Base, Class B Insulation, NEMA B, High Starting Torque, Ball Bearing

HP	RPM	Voltage	NEMA Frame	Thermal Prot.	Service Factor	Approx. F.L. Amps
1/3	1800	208-230/460	56	Auto	1.35	1.5-1.6/0.8
1/2	1800	208-230/460	56	Auto	1.35	2.3-2.4/1.2
3/4	1800	208-230/460	56	Auto	1.25	2.9-3.0/1.5
1	1800	208-230/460	56	Auto	1.15	3.5-3.6/1.8
1 1/2	1800	208-230/460	145T	Auto	1.15	4.8-4.8/2.4
2	1800	208-230/460	145T	Auto	1.15	6.2-6.2/3.1
3	1800	208-230/460	145T	Auto	1.15	9.2-8.6/4.3
5	1800	230/460	184T	Auto	1.15	13.2/6.6
7 1/2	1800	230/460	213T	Auto	1.15	20.0/10.0
10	1800	230/460	215T	Auto	1.15	26.6/13.3

Totally Enclosed-Fan-Cooled, Rigid Base, Class B Insulation, Class F (182T -254T), NEMA B, High Starting Torque

HP	RPM	Voltage	NEMA Frame	Approx. F.L. Amps
1/3	1800	208-230/460	56	1.5-1.6/0.8
1/2	1800	208-230/460	56	2.3-2.4/1.2
3/4	1800	208-230/460	56	2.9-3.0/1.5
1	1800	208-230/460	56	3.5-3.6/1.8
1 1/2	1800	208-230/460	145T	4.8-4.8/2.4
2	1800	208-230/460	145T	6.0-5.8/2.9
3	1800	208-230/460	145T	8.6/4.3
5	1800	230/460	184T	14.0-13.2/6.6
7 1/2	1800	230/460	213T	21.0-20.0/10.0
10	1800	230/460	215T	28.0-27.0/13.5

DC Motors - Ampere Ratings and Fuse Sizes

Motors HP	Ratings of DC Motors Full-Load Amperes		Amp. Cap. of Fuses for Recommended Values	
	120 Volts	240 Volts	120 Volts	240 Volts
1/8	1.4	.7	3	3
1/6	1.8	.9	3	3
1/4	2.9	1.5	5	3
1/3	3.6	1.8	5	3
1/2	5.2	2.6	7	3
3/4	7.4	3.7	10	5
1	9.4	4.7	15	7
1 1/2	13.2	6.6	20	10
2	17	8.5	25	12
3	25	12.2	30	15
5	40	20	50	25
7 1/2	58	29	80	40
10	76	38	100	50

Pipe Friction- Fuel Oil 2

Pressure Drop in PSI per 100 feet of Pipe and Tube

NOMINAL SIZES - INSIDE DIAMETERS								
Pipe Size, In.	2.0 GPM	7.0 GPM	10.0 GPM	17.0 GPM	23.0 GPM	30. GPM	40.0 GPM	50.0 GPM
.50	2.337	24.65	56.10	148.75	233.75	408.00		
.75		3.61	7.31	21.25	39.53	64.6	93.5	182.75
1.00	.306	2.00	4.16	11.70	19.55	31.87	54.40	80.75
1.25	.10	.51	1.00	2.55	5.10	8.50	14.88	22.10
1.5		.23	.425	1.10	2.04	3.27	5.70	8.33
2.00			.13	.34	.60	.96	3.10	2.38
2.50			.10	1.62	.30	.51	.94	1.275
3.00					.10	1.74	3.06	4.93

NOTE: Pipe sizes shown apply to standard weight schedule 40 pipe.
Tube is standard copper tubing

FLAMMABLE LIQUIDS FLASH POINTS

Excerpts from NFPA 325, "Fire Hazards properties of Flammable Liquids..."

	Flash Points °F(°C)
Diesel Fuel Oil No. 1-D	100 Min. (38) or Legal
Diesel Fuel Oil No. 2-D	125 Min. (52) or Legal
Diesel Fuel Oil No. 4-D	130 Min. (54) or Legal
Fuel Oil No. 1 (Kerosene) (Range Oil) (Coal Oil)	100-162 (43-72)
Fuel Oil No.2	126-204 (52-96)
Fuel Oil No. 4	142-240 (61-116)
Fuel Oil No. 5 Light Fuel Oil No. 5 Heavy	156-336 (69-169) 160-250 (71-121)
Fuel Oil No. 6	150-270 (66-132)
Jet Fuels Jet A and A-1	110-150 (43-66)
Jet Fuels Jet B	-10 to +30 (-23 to -1)
Jet Fuels JP-4	-10 to +30 (-23 to -1)
Jet Fuels JP-5	95-145 (35-63)

Specific Gravity and Viscosity of Oils

Oils	*Specify Gravity At 60°F	Viscosities In SSU at Various Temperatures							
		30°F	60°F	80°F	100°F	130°F	170°F	210°F	250°F
Auto Lubricating S.A.E.-									
10 Max.	.880 to .935	4,400	1,090	430	240	120	66		
20 Max.	.880 to .935	6,900	1,650	750	400	185	90	57	
30 Max.	.880 to .935	13,000	2,700	1,200	580	255	120	66	49
40	.880 to .935	25,000	4,850	2,000	950	380	150	80	55
50	.880 to .935	58,000	10,000	3,700	1,600	600	220	105	67
60	.880 to .935	100,000	15,000	5,300	2,300	800	285	128	76
70	.880 to .935		22,000	7,500	3,100	1,050	342	150	86
10W	.880 to .935								
20W	.880 to .935								
Fuel Oil-									
Diesel No. 2D	.82 to .95	138	70	53.6	45.5	39			
Diesel No. 3D	.82 to .95	390	145	92	65	48	39		
Diesel No. 4D	.82 to .95	4,400	700	280	140	70	44.2		
Diesel No. 5D	.82 to .95	16,500	3,500	1,500	750	320	136	76.5	54
No. 1	.82 to .95				35				
No. 2	.82 to .95	104	56	45.5	40				
No. 3	.82 to .95	126	68	53	45	39			
No. 5A	.82 to .95	1,480	420	215	125	72	48		
No. 5B	.82 to .95	850	600	490	400	315	235	178	141
No. 6	.82 to .95		72,000	21,500	7,800	2,150	590	225	110
Navy Spec.	.989 Max.	3,300	1,100	600	360	190	100	66	50.2
Navy II	1.0 Max.		24,000	8,600	3,500	1,150	370	160	89
Turbine-									
Heavy	.91 Avg.	4,800	1,280	625	350	170	86	57	
Light	.91 Avg.	770	330	208	138	87	58.8		