

Overview

- High capacity, 300-400kw
- Dual voltage: 208-240/480vAC
- Digital load control, 5 kw resolution
- Touchscreen operator interface
- Data acquisition and recording
- Network units to form large systems

Description

The Simplex dynaMITE is a large capacity, high performance Portable Load Bank designed to provide the manufacturers, distributors and users of large AC generators and UPS systems with sophisticated testing capability. dynaMITE Load Banks feature digital controllers with network control and data acquisition capability. Operator interface is via touchscreen. Load control is via screen keypad. All electrical values display on the screen and are recorded by the system for future data retrieval. Any number of dynaMITE and Electra Load Banks can be combined for large system capacities and networked for central control and data acquisition.

The dynaMITE Series comprises models rated 300-400kw of resistive load at both 240V and 480V, 3-phase. It can be applied at any AC voltage to 480V AC, 50-60 Hertz standard, single or 3-phase. Load step resolution is 5KW.

Features

UL Listed: File Number E151624.

Digital Control: PLC based control with 8-inch color TFT touchscreen interface. MODBUS over RS-485 network communication. See page 3.

Instrumentation: Digital power transducer with Ethernet communication to digital controller. Data display on touchscreen. Data acquisition and recording. See page 3.

Load Elements: Simplex "Powr-Web" chromium alloy, open wire, continuously supported, power resistor. See page 2 for details.



Load Control: 3-Pole contactors.

Load Element Circuit Protection: Branch circuit fuses. One set of fuses each 50KW branch. Fuses are current limiting type, 200KAIC, 600V.

Cooling System: 3-phase, direct-drive fan, 12,500 CFM.

Malfunction Detection System: Protection against fan failure, high exhaust air temperature, high intake air temperature, overvoltage and fan reversal. Exhaust air temperature displays on screen.

Control Power Supply: Dual voltage control power transformer with supply power switchable to internal (generator) or external.

Touch Screen: Easily removable from panel.

Connection: "Cam-Lok" type power connections.



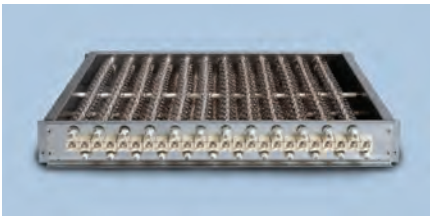

Powr-Web Resistive Load Element

Description

Simplex Load Banks utilize “Powr-Web” load elements. The “Powr-Web” is an advanced design, air-cooled power resistor specifically designed for application to Load Bank systems. The “Powr-Web” is conservatively operated at half the maximum temperature rating of the alloy and features a short-circuit-safe design based on continuous mechanical support of the element by high temperature, ceramic clad stainless steel rods. The “Power Webs” are assembled into discrete trays which are assembled in a vertical “stack.” Each tray in the “stack” is independently serviceable without disturbing adjacent trays.

Specifications

- Alloy: FeCrAl
- Maximum continuous temperature rating: 1920°F
- Maximum operating temperature as applied in Load Bank: 1080° F
- Cool down time from operating to ambient temperature is 10 seconds.

Construction

- Ceramic clad, stainless steel through-rods.
- UL Recognized

Capacity Detail

Model	KW (1.0pf)	FLA			KW DETAIL		
		240V	480V	240V/480V	208/416V	380V	240V, 1-ph
dynaMITE 300	300	721	361	300	225	188	200
dynaMITE 400	400	961	481	400	300	251	267

Cooling System

Model	HP	CFM	ΔT, Nom.	ΔT, Max.
dynaMITE 300	1.5	8,500	110°F	290°F
dynaMITE 400	3.0	10,500	115°F	300°F

Voltage: Dual Voltage: 240/480V AC, 3-phase Operational at any voltage to 480V AC maximum, single or 3-phase

Frequency: 50, 60 Hertz standard

Connection: 3-wire plus ground

Time Rating: Continuous

Ambient Air Temperature: 120°F max

Fault Rating: 200KAIC

Insulation Rating: 600V, 302°F

Net Weight:

dynaMITE 300: 800 lbs.

dynaMITE 400: 1,000 lbs.

Control/Fan Power:

- Internal 208-240/416-480V, 3-phase, 60hz
- Internal 220/380-416V, 3-phase, 50Hz
- External 208-230/460V, 3-phase, 60Hz, 11/5.5A
- External 220/380-416V, 3-phase, 50Hz

Digital Load Step Control

Nominal 5.0 kw resolution: direct enter any load value and controller will apply load within nominal 5kw resolution

Digital Load Calibration Versus Voltage

Controller automatically calibrates loads for reduced voltage operation.

Digital Control and Data Acquisition System

PLC based digital control with 8-inch color TFT touchscreen operator interface.

Functions

- Control power source and voltage level detection
- Malfunction detection and protection
- Direct access (keypad) load control
- Alternate mimic panel load control
- Basic automation of load control
- Field adjustable exhaust temperature limits with temperature display
- Built-in control from customer supplied computer

Instrumentation

Digital power transducer to digital controller and meter displays on touchscreen:

- 3-phase voltage (each, L-L)
- 3-phase current (each line)
- Frequency
- KW

Data Acquisition

- Captures and records all electrical values
- Start recording/stop recording screen buttons
- One second sample rate
- Exports text file to detachable flash drive which plugs into USB port

Outputs

MODBUS (standard) or BacNet (optional):

- Load applied
- Each electrical value as above

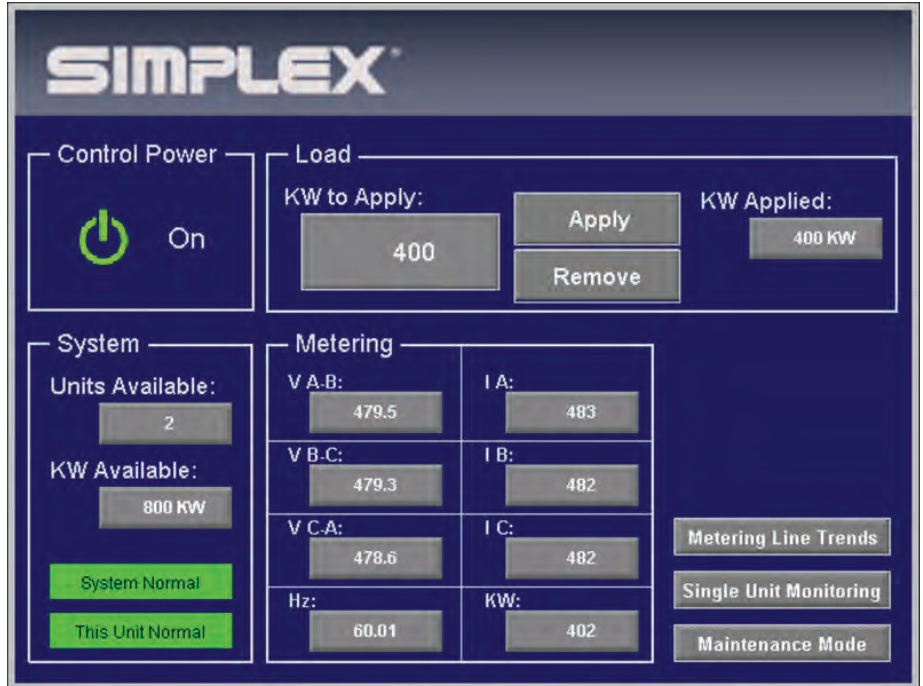

Main Screen

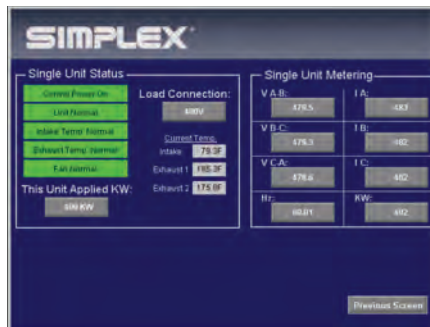

Monitoring Screen

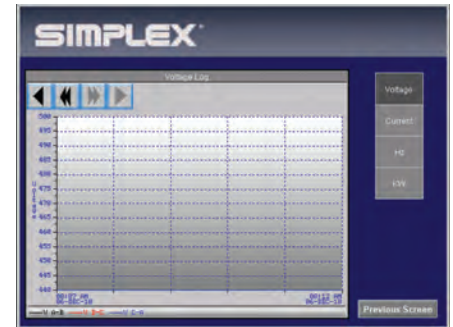

Metering Trends Screen

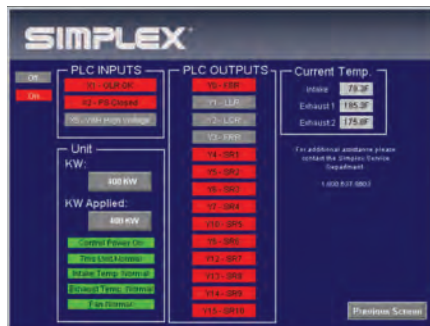

Diagnostics Screen

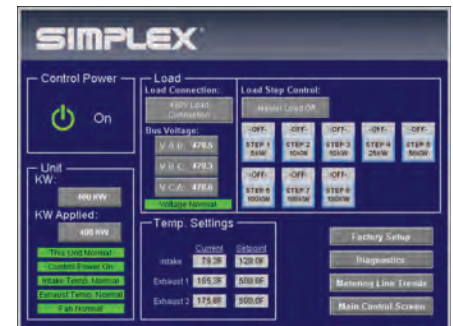

Maintenance Screen

Dimensions and Key Features

- | | | |
|---|---|--|
| 1. Cam-Lok Type Power Connections
Compartment behind Hinged Door | 4. Instrumentation & Controls behind
Doors | 9. Ventilation Louvers |
| 2. Behind Connections Compartment:
Removable Access Panel to Rear
Distribution Bus, Fuses, Contactors | 5. Removable Access Panel to Front | 10. Removable Access Panel, Both
Sides, to "Powr-Web" Load Element
Trays |
| 3. Cable Exit-Allows Rear Door to
Close | 6. Rubber Tired Caster, 6", Front
Swivel, Rear Fixed | 11. Cooling Air Intake Louvers |
| | 7. Screened Hot Air Exhaust | 12. Fork Lift Channels |
| | 8. Lifting Eyes | |

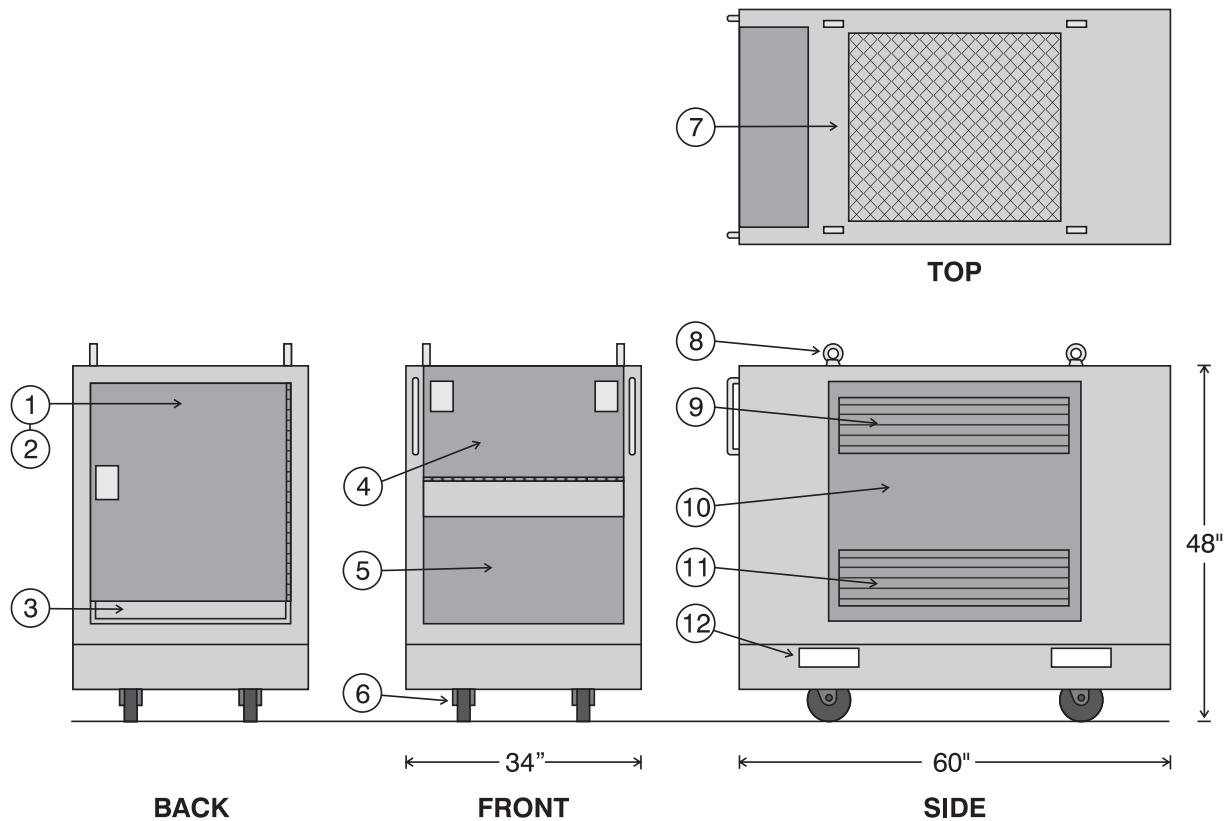

Options

- Network control cables, 25-foot basic length
- 400Hz modification
- Remote control cable extensions
- Simplex AUTO-TEST software for full automation of testing with data acquisition and report generation
- 12' connection cable set including 3-phase power cables, ground cable, stored in rear compartment
- Weather resistant enclosure
- Auxiliary inductive load banks with network control and data capability